



DAC IV *PLUS* USERS MANUAL REV 1 (12/2012)

SIGN MAGNITUDE LADDER DAC SPECIFICATIONS

INPUTS:	BNC, COAXIAL, TOSLINK, BALANCED AES/EBU, MSB PRO I2S AND A BALANCED ANALOG INPUT, RS232 CONTROL PORT
RCA OUTPUTS:	2.62 V RMS (7 Vpp)
RCA OUTPUT IMPEDANCE:	53 OHMS WITHOUT VOLUME CONTROLS, 38 OHMS WITH VOLUME CONTROLS
BALANCED OUTPUT:	5.23 V RMS (14 Vpp)
BALANCED OUTPUT IMPEDANCE:	106 OHMS WITHOUT VOLUME CONTROLS, 76 OHMS WITH VOLUME CONTROLS
VOLUME CONTROL (OPTIONAL):	SIGNATURE: 1/4, 1/2 OR 1 dB STEPPED ATTENUATOR, (78, 156 OR 312 STEPS) PLATINUM: 2 dB STEPS
SAMPLING FREQUENCY:	32 kHz TO 384kHz
BIT DEPTH:	32 BIT
MODELS:	PLATINUM <i>PLUS</i> AND SIGNATURE <i>PLUS</i>

Warning! The DAC IV uses a high current power connector that requires a two step plug in. Push the connector firmly in about 1/4", then push harder and it should snap in another 1/8". When plugged in, the connector housing extends into the metal back. Check both ends.

DAC IV PLUS USERS MANUAL

UNIQUE PRODUCT - A PREAMP OR A DAC?

This product has the option to be a unique combination of a very high performance DAC and the ultimate passive preamp. It is intended to be used as both for the best possible sound in your system. Our preamp philosophy is based on the belief that from the moment analog audio is created, every transition that is made degrades the quality. That means that an active preamp with many stages if perfect would have no effect and any imperfection would result in degradation of the music. That is why we offer a passive preamp within the DAC IV, to achieve the simplest, shortest possible signal path, with the least possible degradation of the true music.

THE VOLUME CONTROL UPGRADE

The DAC IV has one analog input with the option for a second, and many digital inputs. It is designed to be the last component in your system before the amplifiers. With its incredibly low impedance, especially for a passive preamp, it can drive long interconnects and handle any type of amplifier input stage design with optimum performance.

Depending on how many analog sources you have in your system, you may be able to eliminate your current preamp. If you currently have only CD and vinyl in your system, you would attach your CD players digital output to the DAC IV and the output of your phono preamp to the analog input. Your system is now complete, with the shortest possible signal path and the best sound you can achieve. The same idea applies to use with an SACD or Universal player. The MSB Universal Player provides the highest quality SACD playback via the MSB Network.

If you have a complex system with a preamp with many analog inputs, attach the outputs of your preamp to the input on the DAC IV. Shift any digital sources over to digital inputs on the DAC IV and again, you will achieve optimum results. Set your preamp to a volume that matches the DAC IV output and use nothing but the DAC IV volume control in your system.

The volume control modules can be easily installed or removed by your dealer.

SETUP AND QUICK START

The front panel is quite simple with few user controls. Input source select defaults to auto. On power up, the volume is reset to -30 dB. Turn the volume knob up until you hear music.

***Power** - The Platinum comes with a range of outboard power supplies. The supply automatically detects and switches between 240V and 120V. This is not a switching supply that works at any voltage, but a linear supply with automatic switching of the transformer leads. Always allow three to five hours for the Platinum to warm up and reach thermal equilibrium.*

***Inputs** - The Platinum comes standard with one MSB PRO I2S (CAT6), AES/EBU balanced, coaxial (RCA and BNC) and optical digital audio inputs, as well as a balance analog input, ranked in order of performance. Connect any digital input to any active digital audio source. The frequency and bit depth of the incoming signal will be read out on the front panel and analog audio will be found on both balanced and single-ended analog outputs.*

Outputs

Connect the balanced or single-ended analog outputs to any amplifier and audio should be present. The output level is controlled with the knob or remote.

BURN-IN

The concept of burn-in is little understood. Does it take your ears some time to get used to the incredibly detailed and life-like sound of an MSB product or is something actually changing? The feedback we receive leads us to recommend at least 100 hours of burn-in on this DAC. Customers generally recommend one month.

Warning: Please verify that the DAC IV you just purchased is covered under warranty. This DAC was sold to the Distributor named on your box label and in the "about" section of your setup screen. The country and date of manufacture is also specified. If the country and year do not match your purchase location, your warranty may be invalid. Check with MSB.

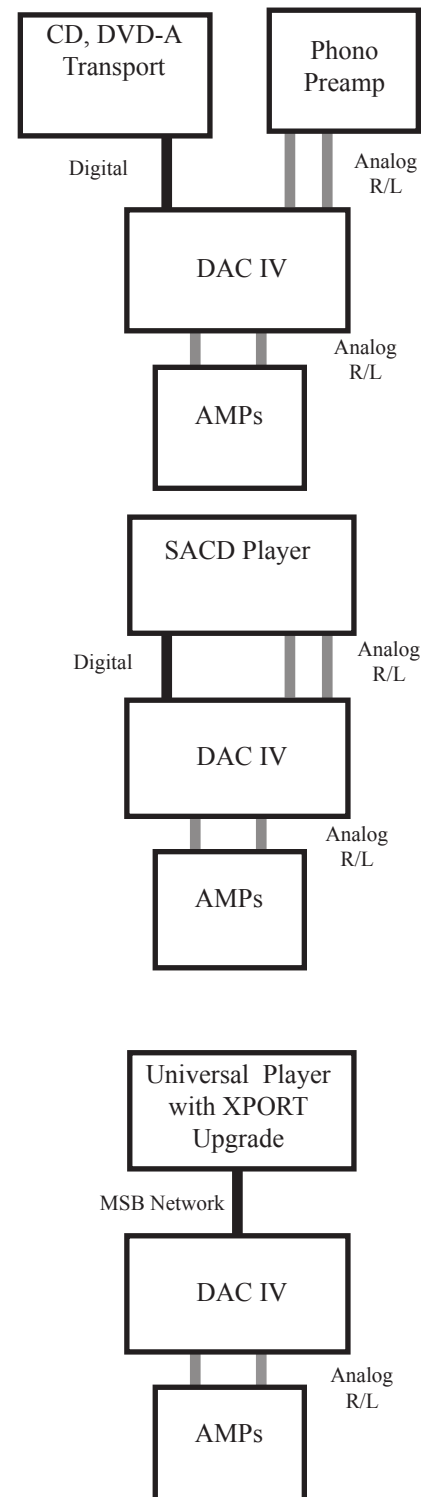



The Signature Data CD is a great companion to the DAC IV. It is shown here with the Signature Transport Power Base in Satin Black.



Here is the complete MSB System, available in Matt White or Satin Black.

iLINK II UPGRADE

This option adds an iPod dock to the cover of the DAC IV. There are no setup options or controls. Plug in the iPod and press play. In addition, the square remote buttons can be used to control the iPod.



* The stop button actually turns off the iLink. This releases the DAC input when auto select is on. Play will turn the iLink back on but be patient as it takes a few seconds for the iPod to reconnect.

* Play / Pause starts and stops playback.

* Forward and Back jump to the next track in the playlist.

The iLink II will charge the iPod when plugged in. It works well with all Generation 6 or later models including the classic, touch and nano models. It also seems to work with the iPhone.

You may add this option any time by swapping the cover.



UNIQUE TECHNOLOGY - THE PAST AND THE FUTURE

In the 1980's early DACs were all 16 bit ladder DACs, with a precision laser-trimmed resistor creating the appropriate analog level for each of the bits. The DACs worked well and sounded good. They were quite expensive as very accurate resistors were required. Then along came the "single bit" DACs. Rather than using a resistor to create an analog level, pulse width modulation was used. Basically each bit was created by turning a switch on and off for the appropriate length of time. The resulting square wave pattern was filtered to create a smooth output. The expensive resistors were gone, and so was the good performance. Next came the Delta Sigma DAC. It used the same pulse width modulation but rather than creating a single large pulse for each data point, the data point was created with many small pulses. This allows the pulses to be smoothed with a less radical filter, and improves the sound. As you can see, upsampling the input signal to a higher frequency reduces the filtering requirements and thus improves the sound.

The DAC IV draws from the older, superior ladder technology, but with incredible improvements. The Basic Platinum contains four 24 bit MSB DAC modules (seen below). The Platinum is fully balanced so there is a matched pair of 24 bit DAC modules for the inverted and non-inverted signals on each of the right and left channels. Finally, each DAC module contains one R2R ladder DAC with a 23 bit negative sign and one R2R ladder DAC with a 23 bit positive sign. Together this makes a true 24 bit DAC. This design allows the quieter moments in your music to be true to the music, without the linearity errors near zero that plague normal ladder and delta-sigma DAC designs. With a dual 24 bits of combined resolution, a 24 bit source gives a true 24 bit resolution without the losses and errors that make your normal 16 or 24 bit DAC perform far less than their actual resolution (normal 16 bit DACs only muster a meager 12 bits of resolution). The DAC IV is carefully designed so as to require no DC correction in the output stage. This allows direct DC coupling on the output stage for pure, uncolored sound -- with no output filtering to muck up your high end or smear your bass attack.

Another major difference in the DAC IV is the type of output. Essentially all ladder DACs produce a current output. This is converted to a voltage output with a current-to-voltage converter. This problematic circuit colors the sound and introduces non-linearity. The DAC IV is a true voltage DAC with a voltage output right from the source. All amplifiers have slew rates greater than 1000 Volts/microsecond. The output impedance of the DAC IV is 53 ohms.

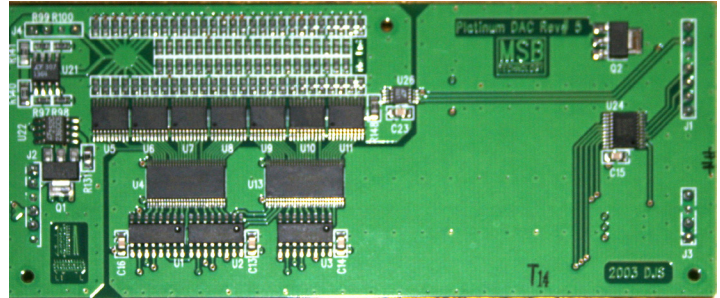
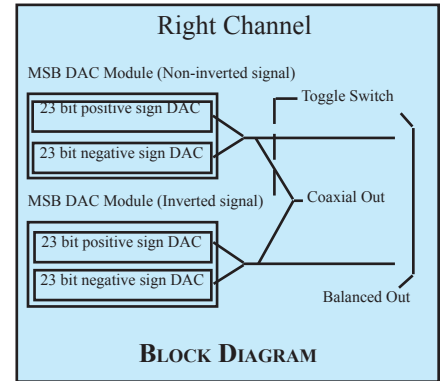

Second Generation Platinum DAC module - Smaller but mor bits!

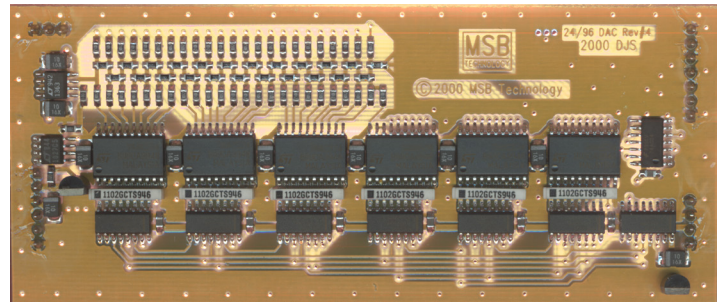

Original Platinum DAC module



The Dual Signature DACs produce 25 bits of resolution, twice the number of steps as the 24 bit Platinum.

SPECIAL FEATURES

The DAC IV has many special features. The following sections discuss these features and how they work. As MSB Technology has developed, so has our DAC architecture. Our advanced digital filter now replaces the asynchronous upsampling of earlier models. The 32X Digital filter goes way beyond our older 16X filter and 4X upsampling. To play a 32 bit/384 kHz file the Platinum only needs to be plugged into the MSB Data CD IV player and a DVD with a 32/384 .wav file needs to be played. The new relocking feature dynamically buffers and re-clocks all the data and clock signals to provide a virtually jitter-free source directly to the DACs.

THE DAC STORY

DELTA SIGMA DACS (SINGLE BIT)

How DACs WORK

A DAC is a circuit that converts digital measures of audio amplitude in discrete steps into a continuous analog electrical equivalent of the sound to be reproduced. The amplitude is a digital number (like a 16 bit word) and the steps occur based on the sampling rate (like 48,000 times per second). This process is very much like an endless conveyer belt with empty one gallon jugs on it, moving by a filling station. The size of the jug is fixed, the rate they pass by is determined by the sampling rate. The goal of the DAC is to fill each jug to exactly the right level specified by the music. There are three techniques used to accomplish this; Delta Sigma, Ladder, and the MSB Sign Magnitude Ladder.



LADDER DAC

A ladder DAC is different in that instead of a single measuring cup (or bit), a whole array of cups are available, from very small to very large.

Any combination of cups can be used to fill each jug to exactly the right level.

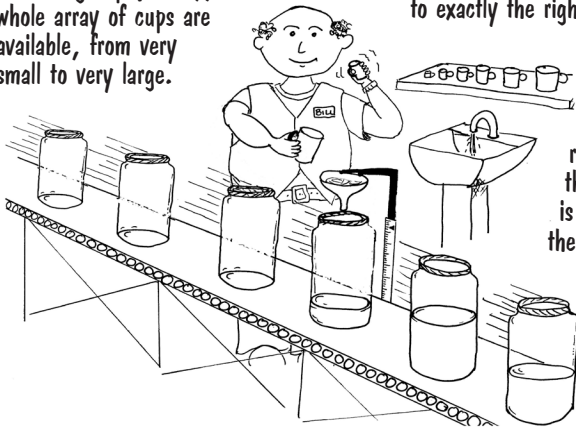

No filtering is required but the accuracy is defined by the cumulative error of all

WHAT ABOUT JITTER?

Jitter is a variation in the speed of the conveyer belt. With a Delta Sigma DAC, the quantity of water ending up in the jug is dramatically affected by the speed change because the whole cycle is occupied with the application of many small scoops of water. With either Ladder DAC method, all the water is placed in the jug at the same time, and even if the jug is a little ahead or behind in the conveyer belt, the quantity is still accurate. That is why we never heard much about jitter until the first Delta Sigma DACs arrived on the scene.

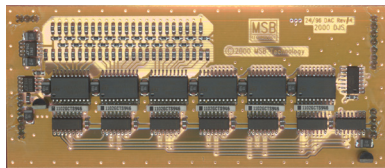

THE MSB PLATINUM DAC

No commercial DAC is available with the level of accuracy we wanted without filtering, so we produce our own using discrete logic and resistors in a DAC module. MSB is unique in this respect. The result is a signal-to-noise rating of up to 140 db and THD+Noise ratings near the theoretical limit of a 24 bit source.

Each sample or jug is filled to the right level with many measuring cups, poured to reach the target level.

A "one bit" measuring cup is either full or empty. With 64 times over-sampling, the cup is only 1/64th the volume of the jug. This rather crude cup does not come close to being accurate enough. The cup would need to be 1/16,777,216th the volume of the jug to be accurate.

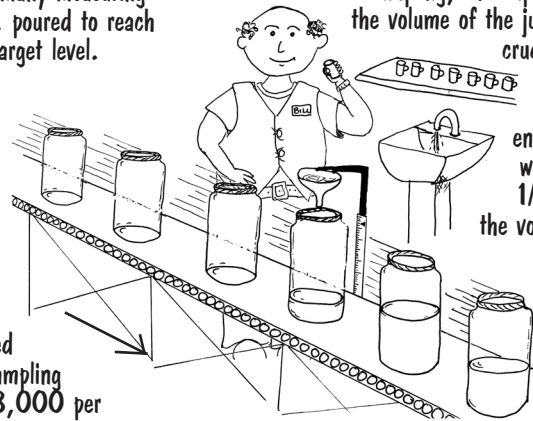

Line speed is like Sampling Rate (48,000 per

By keeping a running tally of the error and by going a little over and a little under in many many samples, a very accurate average is reached, but only with an aggressive filter applied to the output.

MSB SIGN MAGNITUDE LADDER DAC

The MSB Sign Magnitude Ladder DAC is like a Ladder DAC but refined in two ways.

Because the jars are typically 1/2 full when finished, we start with very accurately 1/2 filled containers instead of empty ones. From there, we again use the wide range of measuring cups to either add or take away from each jar.

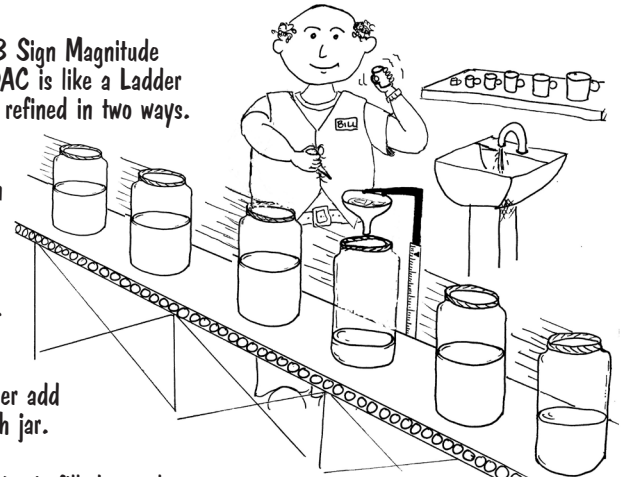

Again each jar is filled exactly so no filtering is needed, but because we only had to add or subtract a little bit our accuracy is higher. Because our hearing is most sensitive to low level sound (sound near the 1/2 full zero crossing) our DAC is most accurate near 1/2 full where we use the smallest and most accurate measuring cups.

WHAT ABOUT UPSAMPLING?

Synchronous Upsampling like MSB does just means adding more jars between the existing jars and moving them faster down the line. By looking at many jars before and after the new empty one, we calculate how full to make it. The result is smaller steps as shown in the waveform.

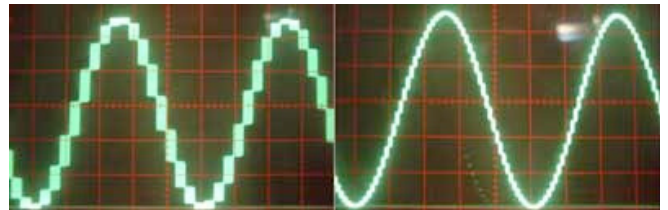

The menu selectable digital filters (from the optional digital filter suite) permits the user to choose the filter design they prefer. It allows for the selection of a standard brick-wall filter or a slow roll-off filter, both at half the sampling frequency. Each provide a distinct, glorious listening experience. You may favor one or the other, or enjoy changing the filter response to suit the music you listen to. Music with less high frequencies may benefit from the slow roll-off 16x filter.

To play all kinds of media such as BluRay or SACD, your player needs to have an MSB Network or XPORT output. If your player does not have the MSB Network output, it can be added.

UPSAMPLING

Upsampling has been in and out of vogue for many years. Its benefit has been obvious in one DAC and nonexistent in another. Here is a simple explanation of why MSB feels upsampling is important. Typically the most processor intensive task in a DAC is the digital filtering. A digital filter takes a look at a window of the music being played, and because that music was received from a digital source, there are holes in it, between data bytes. The filter looks at the shape of the signal in the window and tries to figure out what the missing data is. The bigger the window, the better a job it does, and the bigger processor is needed.

Well depending on the sample frequency of the incoming data, a different digital filter is run. Each is a little different and each may not sound the same. As a result, CDs at 16 bit and 44.1 kHz might sound better or worse than 24 bit 96 kHz files in a particular DAC. But generally, the higher the sampling frequency, the more processor power can be applied to look at a bigger window and the better job the digital filter can do. So we recommend synchronous upsampling, where the original data points are preserved, but the spaces between them are filled in.

UPSAMPLING
EFFECT

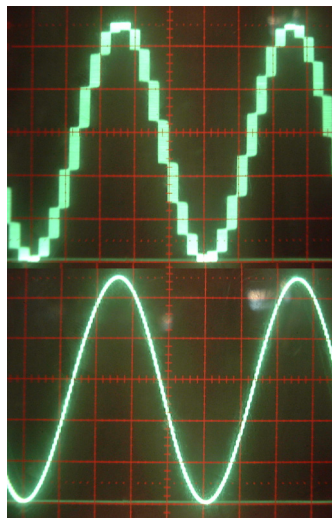

SIGN WAVE (0 DB, 19.95 KHZ TEST TONE)
SCOPE SETTINGS 2 V/DIV, 10 USEC/DIV

CUSTOM MSB DIGITAL FILTER

The DAC IV has a custom DSP based Digital filter. The sine x function is the ideal shape to apply to the audio filter task, but unfortunately to work perfectly it must sample an infinite number of samples. Our 16x filter contained 3200 taps, a very large sample and worked well. The 32x Filter contains an amazing 6000 taps, and the increased size of the filter more closely approximates the ideal filter. Immediately you can hear the increased clarity of the music.

MSB has applied noise shaping technology, not directly to the audio as SACD and Delta Sigma DACs do but to the actual digital filter. This novel approach reduces that digital harshness without loss of detail or focus.

Just as glasses bring an image into focus for eyes that are not perfect, we have applied a corrective algorithm to the slight imperfections specifically found in our DAC architecture. This new innovation focuses the instruments more accurately on the soundstage.

MSB Digital Filter History and Detail

One of our primary goals at MSB is to provide the music lover with the most accurate musical experience possible. During years of careful design and improvement of our custom discrete DACs, which form the heart of your Platinum DAC, we realized that the Platitudes sound quality was no longer limited by them. We soon narrowed the problem to the Digital Filter which was feeding our DACs. While the excellent Burr-Brown (Now owned by Texas Instruments) DF1704 Digital Filter had served us well in the past, it had become the bottleneck once we started using our new Second Generation DAC modules. After a thorough search of all the available off the shelf and custom DSP based Digital Filters we realized that little improvement could be had from any of them. With no other option in sight we decided to build our own solution.

Converting the ones and zeros of Digital Audio into music is an enormously delicate and critical process. Each individual sample that makes up the audio stream must be converted into the high resolution, continuous analog voltage that can be transformed into the sound that you hear. Any misstep can corrupt the final result ending with audio that does not sound anything like the original recording. Errors in translation can make a harsh, veiled, muddy, and/or tonally colored result. Minimizing each potential problem allows the original recording to shine through.

Audio reproduction starts when the DAC receives the binary coded information from the source. The first step requires recovering the audio samples, which represent the final output voltages, and the timing, which tells the DAC when to output those voltages. Next the sample rate is raised and the data is digitally filtered. While it is possible to feed the DAC with the original audio samples thereby avoiding the use of a digital filter skipping this step has many unintended consequences. After being digitally filtered the digital stream is feed to the DAC. The DAC receives the digital audio samples and converts them into a continuous analog voltage. Our DACs instantly convert the data into a precise continuous voltage waveform with timing determined by the DACs conversion clock.

The digital filter is necessary because mirrored image frequencies created during the conversion process must be removed. If the DAC did not have a digital filter, an analog filter with an aggressive response must remove these image frequencies. These brick wall analog filters seriously damage the signal by corrupting the original phase of the sound and cannot fully remove the high frequency images. This results in harsh or rolled off high frequencies and poor soundstage focus.

Traditional digital filter designs consist of cascaded FIR (Finite Impulse Response) filters, each of which raise the sample rate by two. The intermediate data between the filters is usually stored at less than 40 bit resolution. Since the next filter works with previously computed data the resolution decreases with each filter pass. This limits higher quality digital filters to a low oversampling rate (usually 8x) before the output starts to deteriorate. The loss in resolution is typically not apparent when using the best conventional digital filters with standard DAC chips, but in combination with our high resolution DACs the problem is very apparent. The sound becomes muddy, veiled and un-involving when using any off the shelf digital filter. To counter this problem the MSB Digital Filter does it's filtering in one filter stage that raises the sampling rate by 32.

FIR filters operate by multiplying each sample in the data by a set of filter coefficients and then summing the result. Most digital filters round the result of each addition before

the adding next sample. This repeated roundoff results in a similar problem to the cascaded 2x filter approach, muddy sound. MSB's digital filter uses bit perfect accumulation in an 80 bit accumulator completely eliminating these debilitating roundoff errors. Only as the last step do we carefully convert the audio to the 24 or 26 bits our DACs require. The high sampling rate of the output allows us to include advanced ultrasonic dither and noise shaping techniques in this step to achieve greater than 24 bit effective resolution.

Through extensive listening tests we have found that the choice of filter coefficients has a great impact on the tone of the music. We have found that steep, phase perfect "Brick Wall" filters tend to sound the most neutral but are also the most difficult to implement without problems. Improvements we have made in our digital filter, with its single stage design and 80 bit computation, allow us to use very steep filters with no compromises.

Custom Filter Options

We recognize that different people often have very different taste in their music. For those who do not like the standard choice of filter, or require a different filter response, we have provided a very easy method for customizing your MSB Digital Filter. By playing a standard CD containing a custom filter algorithm you can temporarily change the filter inside your Digital Filter. This CD filter loading allows you to load almost any FIR filter quickly and easily. You may also upgrade your MSB Digital Filter with the latest custom software just by playing a special Firmware Upgrade CD.

The timing of the DACs conversion clock also has a large impact on sound quality. Any periodic frequency change or "jitter" causes a loss of focus in the reproduced audio. The high power and large memory space of the SHARC DSP we use allows us to offer a unique Ultra Clock to your MSB Digital Filter. The Ultra Clock adds two ultra precision, ultra low jitter TCXO oscillators and custom clock handling circuitry to your board. This custom circuitry allows us to do much more than simply re-clock the data, as other jitter reduction boxes do, but completely replace the incoming clock!

Most jitter reduction schemes rely on Phase Locked Loops or Asynchronous Sample Rate Converters. The Phase Locked Loop is able to reduce jitter to a significant degree but not eliminate it because the output clock must be related to the input clock. The Asynchronous Sample Rate Converter, which completely replaces the data and clock, seems ideal until you realize that the complex computation involved harms the data by permanently imbedding a portion of the clock jitter into the data. Sample Rate conversion is also detrimental to the sound due to the complex and sub optimal digital filters involved, which must change their filter response to track minute changes in the input to output clock ratio.

The Ultra Clock sidesteps both of these problems by storing the incoming data in an extremely large buffer (1/2 second of audio.) The on-board clock then reads out the data without jitter. The on-board clocks are totally independent from the input clock so that no jitter is transferred to the output. True absolute digital silences such as a track skips are selectively shortened or lengthened by the DSP to keep the buffer synchronized. This process is carried out seamlessly by the DSP to assure that all compatible sample rates have their clocks properly replaced. Compatible sample rates are 44.1 kHz, 48 kHz, 96 kHz, 176.4 kHz, 192 kHz, 352.8 kHz, and 384 kHz. Other sample rates automatically use the recovered clock from the transport without user intervention. The large delay caused by the buffer with 48 kHz sample rate audio from a DVD movie may cause the audio to be unsynchronized. You can turn this feature off with the remote.



ABOUT THE CLOCK / JITTER CONTROL

Jitter control devices (and inputs on most DACs) normally re-clock the input signal in attempt to lessen the jitter of that incoming signal. The DAC IV does no such re-clocking. We actually pay no attention to the clock on the input signal. All internal clocks are generated by an extremely accurate plug-in clock. Since the input clock is no longer related to the clock of the DAC IV, an intelligent 1/2 second buffer is used to maintain data synchronization.

A clock header is a part of the DAC IV that will allow even more accurate clocks to be installed as an upgrade as they become available. Clock jitter seems to be the single biggest contributor to digital harshness. MSB clocks are the lowest jitter audio clocks in the world. The DAC IV plus models are supplied with the Femto 140 Clock with about 140 femtoseconds of jitter. The Galaxy Femtosecond Clock is a great upgrade and offers about 77 picoseconds of jitter.



THE FEMTOSECOND GALAXY CLOCK OFFERS THE LOWEST JITTER IN THE WORLD AND IS A GREAT UPGRADE.

CUSTOM SOFTWARE AND TEMPORARY FILTERS

A custom digital filter will allow you to tailor the sound of your Platinum. Any form of custom FIR filter may be loaded into the MSB Digital Filter. You may select a custom filter from our library, you may have MSB design a filter to your specifications or you may send MSB a list of Fir Filter coefficients that we can format into a CD loadable file for you. You cannot permanently damage your DAC by loading a Temporary Custom Filter, it is only active until you power down the Platinum. Contact MSB Technology for details on custom filters.

Step One, Verify Your Equipment Compatibility - To successfully load your custom filter you must have your Platinum connected to a transport that will not change the Data. Almost all older CD players are acceptable, however there are some important exceptions. Upsampling CD transports will not work. The Upsampling drives are fine for playing audio after the upload however. DVD players should work fine when they are configured in a mode that does not affect the Data such as CD pass-through mode. The iPod is an excellent way to play this file if you have the iLink upgrade.

Step Two, Burn the CD - When burning a CD containing the custom filter you must burn the .wav audio file directly to a CD without first converting it to another audio format such as MP3. Converting the .wav file to another format will destroy the careful formatting which allows the DSP to load filters directly from a CD. You may however burn other audio to the CD as separate tracks. This allows you to create a CD with a custom sound that differs from the rest of your collection. A suggestion is to place a track containing the Custom Filter on the CD as track 1 and place the Special Filter Cancellation Code as the last track. This will allow a CD to play through with a custom filter leaving your Platinum in the normal filter mode at the end of the CD. With an iPod, these tracks can be included in a playlist.

Step Three, Play the CD or iPod - To ensure a proper load of the filter you must remember to disable any digital processing before the Digital Filter. This includes turning off processing in DVD players, Upsampling in CD Players and Upsampling in the Platinum itself. If the Filter Load Fails because the equipment is not compatible or the track is not played through the MSB Digital Filter the track containing the Custom Filter will play a short tone followed by a Update Failed message. A successful load will just be a short tone followed by a five-second silence.

Step Four, Select the Filter - A custom loaded filter will remain until the power is cycled. To use the filter, look in the setup menu for the “temporary” filter and select it.

LOADING NEW FIRMWARE

Loading custom Digital Filter Firmware will permanently change the operation of your DSP. MSB Technology can configure custom software for your DSP to meet virtually any requirement. Playing a CD track containing the new firmware will erase the current software in your Digital Filter and replace it with the contents of the update file. This is just as safe as loading a Custom Digital Filter if one precaution is faithfully observed. The firmware update process takes about 20-30 seconds and you **MUST NOT INTERRUPT THE POWER TO THE PLATINUM** while the new firmware is loading. You must wait for the message after the Firmware Update before interrupting your Platinum’s power. If the power to the Platinum is interrupted during a firmware update you will have to return the DAC to MSB for reprogramming. MSB will charge you a small fee for this service. If you have accidentally loaded firmware that you do not wish to have on your Platinum do not try to cancel it while it is loading, simply wait for the update to complete and then load the firmware you do wish to have on your DAC.

Step One, Verify Your Equipment Compatibility - To successfully load your new firmware you must have your Platinum connected to a transport that will not change the Data. Almost all older CD players are acceptable, however there are some important exceptions. Upsampling CD transports will not work. The Upsampling drives are fine for playing audio after the upload however. DVD players should work fine when they are configured in a mode that does not affect the Data such as CD pass-through mode. The iPod is an excellent way to play this file if you have the iLink II upgrade.

Step Two, Burn the CD - When burning a CD containing the new firmware you must burn the .wav audio file directly to a CD without first converting it to another audio format such as MP3. Converting the .wav file to another format will destroy the careful formatting which allows the DSP to load filters directly from a CD. With an iPod, these tracks can be included in a playlist.

Step Three, Play the CD - To ensure a proper load of the firmware you must remember to disable any digital processing before the Digital Filter. This includes turning off any processing in DVD players, Upsampling in CD players and Upsampling in the Platinum itself. If the Filter Load Fails (the equipment is not compatible or the track is not played through the MSB Digital Filter) the track containing the new firmware will play an introduction and a short tone followed by a Firmware Update Failed message. With a successful load the tone will just be followed by a 5 to 15 second silence followed by music. The new firmware is loaded but not running at this point, you need to press any button or change any menu to activate the change.

Step Four, Enjoy Your New Features - Custom Firmware permanently changes the software running on your DSP. This change occurs immediately following a firmware update. A firmware update will not change the names of your menus, but may change the function they perform. If you are not happy with your new firmware simply load your old firmware using the instructions above.

REAR PANEL ANALOG DETAILS - (LEFT TO RIGHT)

Right Analog Single-Ended RCA Output – This is the primary single ended RCA analog output. For optimum performance, select single-ended mode from menu. This uses both DACs to gain an extra bit of resolution, but disables the Balanced Outputs. The output impedance is 38 ohms with volume control and 53 ohms without, and output level is 7 Volts PP (2.62 V RMS).

Right Analog Single-Ended RCA Alternate Output – This is the alternative single-ended RCA analog output. When the DAC is set in the single-ended mode, this output is exactly the same as the primary output. When the DAC is in the Balanced mode, this output becomes an inverted version of the RCA output. When the DAC is in the multichannel mode, this output becomes the extra channel output. When the optional Second Analog Input upgrade is installed, this becomes a single-ended analog input. As an input, this line should be terminated or connected to a source as it is directly connected to the output when the DAC power is turned off.



Right Analog Balanced XLR Output – This is the balanced XLR analog output. The DAC should be set for balanced mode when using this output. When set to single ended, the differential output will be equal and you will hear nothing. When the DAC is set to multichannel mode, the primary channel will be heard on the non-inverted output pin and the alternate channel on the inverted output pin. The output impedance is 106 ohms with volume control and 76 ohms without, and output level is 14 Volts PP (5.24 V RMS).

Right Analog Balanced XLR Input – This is the balanced analog input. This input is passed to the output with no change unless a volume option is installed. The non-inverted and inverted inputs are also passed to the single-ended and alternate outputs, respectively, regardless of the mode setting. When the volume control is installed, this input can be either volume controlled or not, depending on the menu settings. This input is ideal for adding a vinyl input to your system. Minimum input impedance is 2 kohms. For an RCA input, use an RCA to XLR conversion connector. At 0 dB volume setting, the analog inputs are a direct pass-through.

Left Analog Connections – Same as right above.

Aux One and Two – A second balanced analog input can be installed here, instead of the single-ended option. It can use or bypass the volume control independently of the first analog input.

HOW TO HOOK UP A SUBWOOFER

Main AMP Balanced – Set the DAC for a balanced output and attach main amp normally. Use the single-ended output for subwoofer. (Preferred Configuration)

Main AMP Single-ended – Set the DAC for a single-ended output and attach main amp normally. Use the alternate single-ended output to connect to the subwoofer.

REAR PANEL DIGITAL DETAILS - (RIGHT TO LEFT)

Power Input – This product must be plugged into a DAC IV Platinum or Signature Power Base with both analog and digital supplies. It will not work with any previous MSB power supplies such as the P1000. The Diamond Power Base also makes an excellent upgrade.

RS-232 – The RS-232 input is used for controlling the DAC or volume control using a remote system. Complete command table can be found on the support tab of our web site.

Toslink – Although this format has the lowest bandwidth, it is one of the more common outputs on low-end products. It also offers ground isolation between products and noise immunity over long runs. It is unlikely to work at sample rates over 192 kHz.

Coaxial – A good input for short runs and lower frequencies. Limited to 384 kHz, 24 bit data.

Connector Details

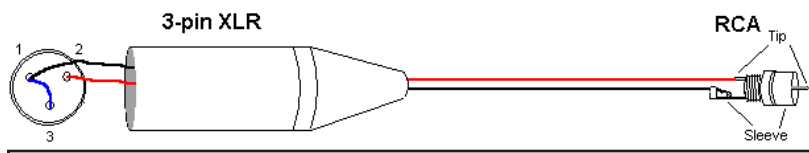

Single-Ended Analog Input Cable

A single-ended analog input can be made out of the balanced input.

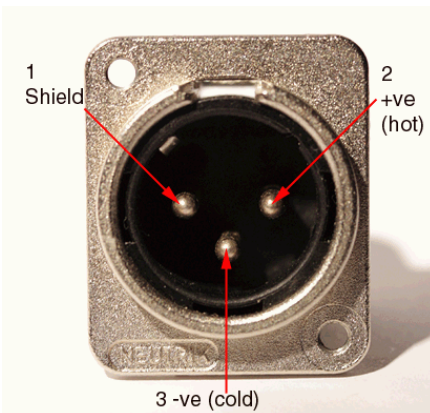

Male XLR (output)

In a case where three single-ended outputs are desired, a cable can be made to extract a single-ended output from a balanced output. Now two single-ended outputs are available, even when the DAC is set to the single-ended mode.

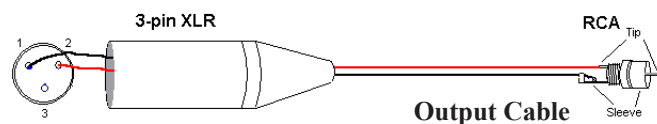

Output Cable

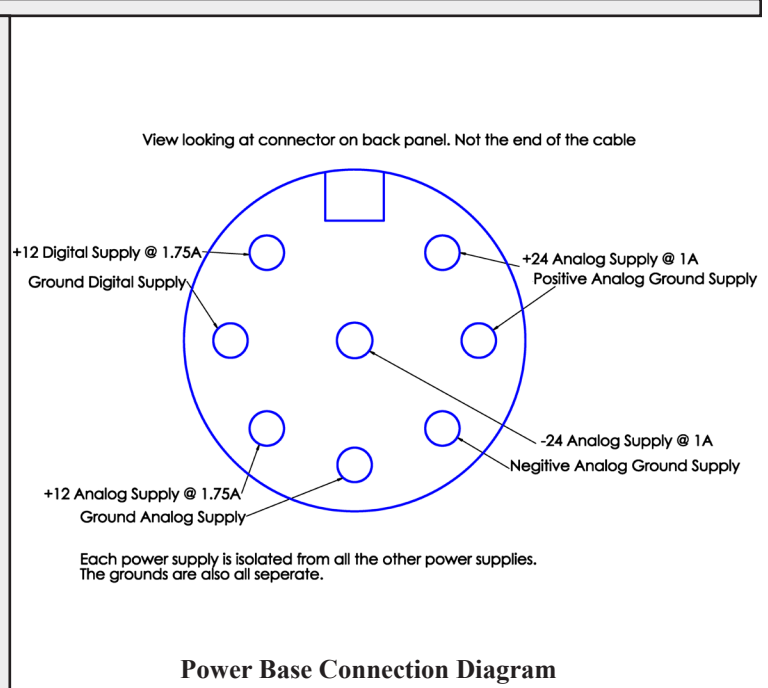

Power Base Connection Diagram

The MSB PRO I2S Network

One of the most powerful features of MSB products is the PRO I2S network. Most new MSB products have a PRO I2S connection available. The MSB PRO I2S has the following capability:

- Works with standard CAT6 cable
- Simultaneous transmission of 8 audio channels with 32 bit resolution at 384 kHz sampling rate.
- MSB CAN Interbox communication Bus (for communications between boxes)
- Low Jitter master clock distribution from the DAC back to the Transport.

This network is our answer to 384 kHz audio transmission and multichannel transmission in the same package. We provide network outputs on our own transports and offer a source upgrade to your transport as well. With multichannel sources, up to 8 channels of decoded data can be sent through one wire to separate DACs. CAT6 wire is very convenient as it has become the standard for all computer networks. Several cables are available for connecting MSB transports to the Platinum Line including CAT6 cable at any length up to 80 feet.



MSB PRO I2S Connector

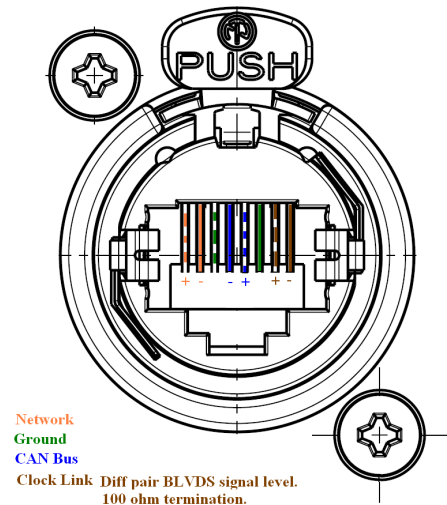

BNC – Same as Coaxial but with a BNC connector. Another digital input.

Balanced digital – The AES/EBU Professional input is the preferred input. The balanced nature of this input allows great cable lengths as well as total noise immunity. Limited to 384 kHz, 24 bit data.

MSB PRO I2S – The MSB PRO I2S uses CAT-6 cabling. It provides an input for use with other MSB products. It can handle 8 channels of data up to 384 kHz and 32 bits. The DAC IV can select which audio channels to decode. This interface also outputs the clock to keep the transport in sync.

Aux 1 and 2 – These are all purpose expansion slots. They can be configured as a USB input, MSB PRO I2S Input, MSB Network or extra XLR or RCA digital inputs. It can also become a second analog input. They will also accommodate anything new that comes along.

CLOCK INTERFACE

After years of experimenting with inputting and outputting clocks we now strongly recommend not doing this. A low jitter clock must be physically close to the DACs. There is no lower jitter clock than the MSB clocks, and even if there were, once the clock was transmitted from an external box so much jitter would be introduced in the cable that the clock would be marginal at best. So we are confident that no benefit would be gained from an external clock.

A different set of problems exist with outputting clocks. A paradox is created as a source needs a clock to transmit data, but when the DAC sees the data, which can be at any sample rate, it adjusts the clock to match. No source can handle its clock adjusted on the fly. Only the MSB Transports can handle this as the PRO I2S interface is smart and negotiates the proper clock to be sent back to the transport. But, if you do have a need to access this clock, it can be done.

Within the MSB Network connection is a clock interface that allows multiple Platinum products to be synchronized, allows the Platinum Clock to be input or output. The interface is a LVDS format clock interface with a signal level of 250 mV pp.

Pin Identification - The pins shown in the figure below are identified as follows:

1. M Clock + (Positive side of balanced Master Clock)
2. M Clock - (Negative side of balanced Master Clock)

Clock Frequencies - The clock can be selected to be either an input, output or turned off in the setup menu. The output frequencies are as follows:

- 44.1, 88.2 or 176.4 kHz sampling frequency source outputs or inputs a clock frequency of 22.5792 MHz
- 48, 96 or 192 kHz sampling frequency source outputs or inputs a clock frequency of 24.576 MHz.



FRONT PANEL CONTROLS

Although the user interface is very simple and easy to use, in depth menus allow complete control of the DAC.

Menu Button – The square button is single purpose. It will enter the setup mode at the top of the menu tree. If in the setup, and it doesn't matter where, this button will exit the setup and return to the normal operational mode.



Input Selection – Each of the six inputs can be selected manually, or the auto mode can be selected. The auto mode is an automatic priority switching with auto signal detection. The right and left arrows switch inputs. If the AUTO input is selected, the unit will automatically switch inputs based on a priority (from left to right - Analog = lowest priority, MSB 2 = highest priority). When a source with a higher priority becomes active, the unit will automatically switch to the new higher priority input. Toggling through the inputs manually will defeat any auto switching. When in the setup menu the arrows move right and left through the menu structure.



User Select Button - The star button is user defined. In the default configuration, it does phase invert. In the setup menu it can be changed to turn upsampling or reclocking On/Off, or to select the digital filter, upsampler algorithm.



Input/Volume Knob - The large knob will select between inputs if the volume control option is not installed. The right and left arrow buttons on the front of the unit will also switch between inputs. When the volume control module is installed, the knob becomes the volume control. This knob adjusts the volume between +9 dB and -69 dB. Our 0 dB actually equates to a 2.62 V rms output, just a little high in relation to the industry standard 2 Vrms level.

Display - The display shows the Input in the upper left. The lower left shows the input sample rate and bit depth. The right shows the volume.

REMOTE

The MSB remote can be used to operate several MSB products. The top half is primary for the transport. The center is for the DAC and the lower part for the iLink.

Power – The power button turns on and off the Power Base when the optional front controls have been installed. If your Platinum Power Base does not have a switch on the front, this button will do nothing. When the power base is linked to the Amplifiers and any other MSB products, this button will turn off the entire system. (see power base manual for details)

Data CD IV controls – . The keypad, stop and repeat buttons are for the DATA CD IV transport and have no effect on the DAC IV.

Volume up and down – The center block of the remote has several functions. The volume up and down buttons change the system remote if the optional volume controls are installed in the DAC. Steps sizes are shown on the DAC display. The mute button instantly mutes the audio if the volume option is installed.

<> = * and # buttons – These central buttons are also for controlling the DATA CD IV transport, but also can be used for navigation of the DAC IV menus. See MENU below.

Input – This button toggles directly through the inputs of the DAC IV even if the DAC is set to the auto mode.

Menu – This is equivalent to pressing the menu button on the front panel and puts the DAC IV into the menu/setup mode. The menus can be navigated from the front panel or using the <>, volume up/down buttons on the remote as left, right, up and down.

1, 2, 3 – These are user defined buttons. They can be programmed in the setup menu to execute any function you wish from the following options.

Phase Invert - Toggles phase invert on and off.

Upsampling - Toggles Upsampling on and off.

Reclocking - Toggles reclocking on and off. This is especially useful for watching movies, where reclocking may cause an objectionable audio delay.

Digital Filter Select - Toggles through the installed digital filters.

Upsampler Select - Toggles through the installed upsamplers.

iLink Controls – Provides basic iPod controls when this option is installed.

Batteries – The remote control requires two CR2025 Lithium batteries.



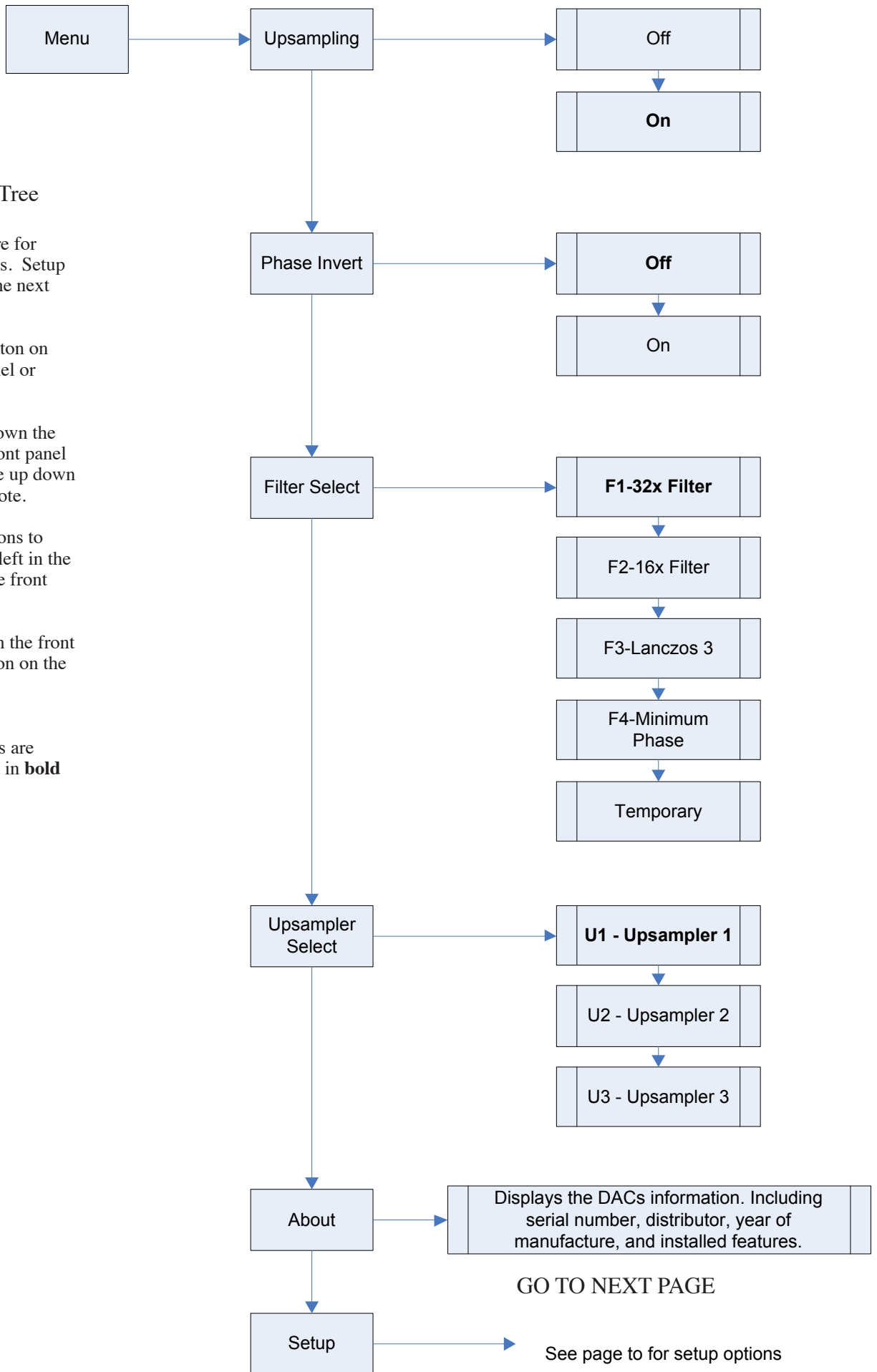

DAC IV Menu Tree

Top level menus are for operational controls. Setup menus follow on the next pages.

Press the menu button on either the front panel or remote.

Navigate up and down the options with the front panel knob or the volume up down buttons on the remote.

Use the arrow buttons to navigate right and left in the menus on either the front panel or remote.

Use the * button on the front panel or the > button on the remote to select.

The default settings are shown on the chart in **bold** type.

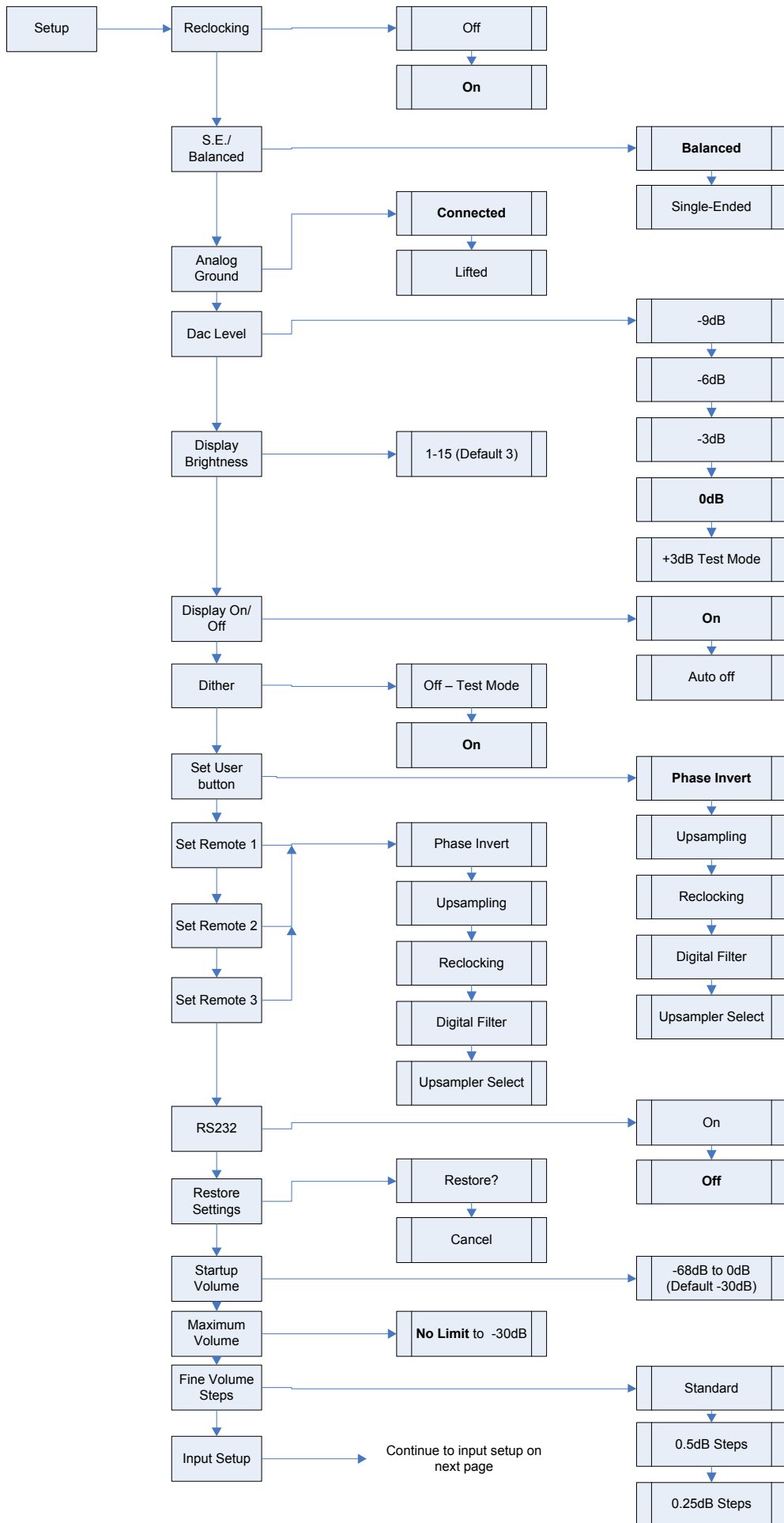

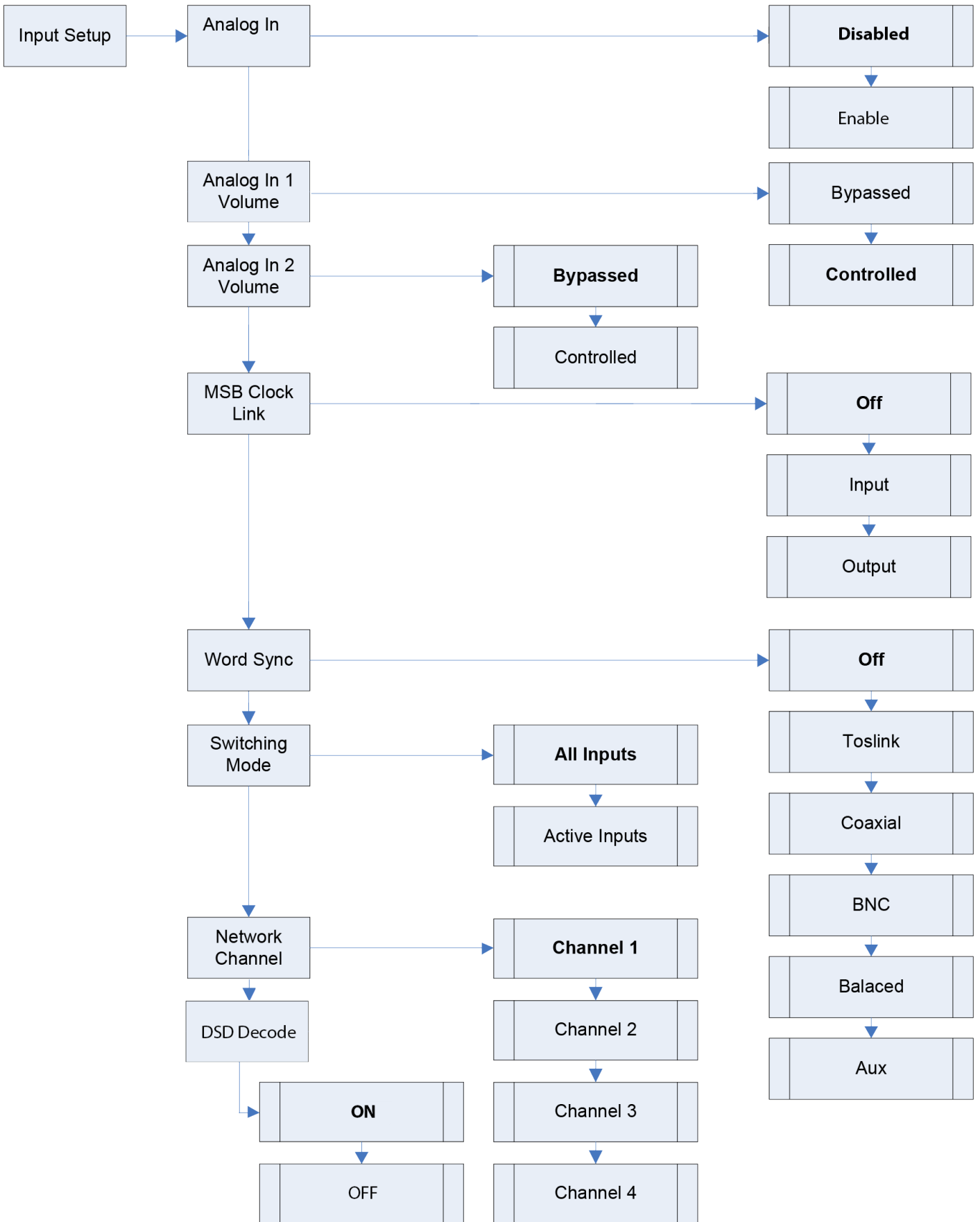

OPERATIONAL MENU OPTIONS

The high level menu options have to do with operation settings. They are things that you may want to change on the fly as you listen to different music or with different equipment. See the Menu tree for details.

Upsampling on/off - Upsamples all incoming music to either 384 kHz or 352.8 kHz.

Phase Invert - Toggling the Phase Invert will change the absolute phase of the output. There are some recordings that “accidentally” swap the phase. For those who are phase sensitive, we always include this option. The phase of the outputs is inverted digitally.

Filter Select - This feature lets you select among a number of preloaded filters. There is not right or wrong filter as the best filter depends on the original recording and the rest of the components in your system. We are always working to develop new and better filters to compliment different system characteristics.

Upsampler Select - Upsampling algorithms may also be selected from among the preloaded options.

User Button - Defines the function associated with the user button * on the front panel.

Remote User Buttons - Defines the function associated with the remote user button 1, 2 and 3 on the remote control.

About - Displays information about the unit including the version number, serial number, distributor, and year of manufacture.

SETUP MENU OPTIONS

The second level menu options have to do with setup parameter - things you will only need to set once. In most cases you will not need to change any of these settings. See the Menu tree for details.

Reclocking - This very important feature of the DAC allow all jitter to be removed from the input source. Data is read into a memory and then independently read out using a ultra stable clock. When enabled this option will completely replace the incoming clock with an ultra low jitter TCXO based clock. The DSP monitors the incoming sample frequency and detects standard sample rate signals, 44.1 kHz, 48 kHz, 88.2 kHz, 96 kHz, 176.4 kHz, 192 kHz, 352.8 kHz and 384 kHz. The on-board clock then completely replaces the incoming clock. Other sampling frequencies use the incoming clock from the source. The DSP allocates a huge internal FIFO buffer (1/2 second at 44.1) that stores the incoming audio to decouple the incoming and outgoing data streams. Long absolute digital silences in the music stream, such as between tracks and during pauses, are selectively shortened or lengthened by the DSP to maintain data synchronization. This results in a significant delay between the audio source and the analog audio. You will not normally notice this delay unless video is synchronized to the audio. For this reason this feature may want to be turned off when watching video, or the video should be delayed. While using the on-board clock some very long musical performances greater than one hour with no silences, pauses or track skips may cause a buffer overflow when using a standard transport. This will sound like a small CD skip. You will probably never encounter this case but if you do MSB can install a special ultra high accuracy clock in your transport or other audio source to totally eliminate this possibility.

Single-ended Mode - This setting optimizes the DAC for single-ended RCA outputs rather than balanced XLR output. In the single-ended mode, both the non-inverted and inverted DAC are summed to make the very highest quality single-ended output, at the expense of the balanced output which is then disabled. In the balanced mode, both outputs work, but the single-ended output is simply the non-inverted output from the balanced output.

DAC Output - This unique feature adjusts the output of the DAC digitally. It is especially useful when no volume control is installed, for optimally matching the DAC output to a preamp input. Many preamps sound much better with a lower level signal. With MSB volume modules installed this setting should be left at 0 db.

Output	Single-Ended	Balanced
+3 dB	3.57 Vrms	7.14 Vrms This setting for measurement purposes only
0 dB	2.62 Vrms	5.23 Vrms
-3 dB	1.79 Vrms	3.57 Vrms
-6 dB	1.27 Vrms	2.53 Vrms
-9 dB	0.98 Vrms	1.97 Vrms

Display Brightness - Adjustable from 1 to 15.

Display on/off - When turned off, the display pops on for a bit any time anything is adjusted, then turns off again.

Dither on/off - With the dither activated the MSB Digital Filter continuously adds a tiny amount (-110 db) of random ultrasonic dither to the Output. We have found through extensive listening tests that this tiny amount of dither greatly increases the perceived resolution of the audio without harming the music in any way. The dither is added separately in common mode to the positive and negative DACs in the Platinum and mostly cancels itself on playback helping to linearize the DACs. The dither is generated by a highly random, non-repeating white noise generator and is then digitally filtered to remove all dither content close to the audio band. All of the dither between 0 Hz and 40 kHz is removed. Unlike some noise shaping algorithms like DSD the very low level of the ultrasonic dither involved should never cause system high frequency related problems. MSB highly recommends that you keep the dither enabled. Dither can be turned off when using our incredibly precise DAC for making measurements.

Restore Settings - Puts settings back to factory default setting.

Startup Volume - This is the volume setting that is set upon power up.

Maximum Volume - This is the maximum volume setting that can be reached. Use this feature to protect your speakers.

Fine Volume Steps - The basic DAC IV volume module has 2 db steps and this feature is not available. With the Signature and Diamond volume modules, this feature allow half or quarter db steps to be inserted between the standard 1 db steps. In most cases this level of resolution is not audible.

Input Setups

Analog Input Volume Control - The analog input can either be volume controlled or bypass the volume control.

Alternate Analog Input Volume Control - The alternate analog input can either be volume controlled or bypass the volume control if this option is installed.

Switching Mode - When the input selector is manually selected, either all inputs are available or just active inputs. With active inputs selected, A/B testing is very quick and easy.

MSB Network Channel Select - The MSB Network supports 4 stereo channels of audio. With this feature the DAC can be configured to decode any of the 4 sets.

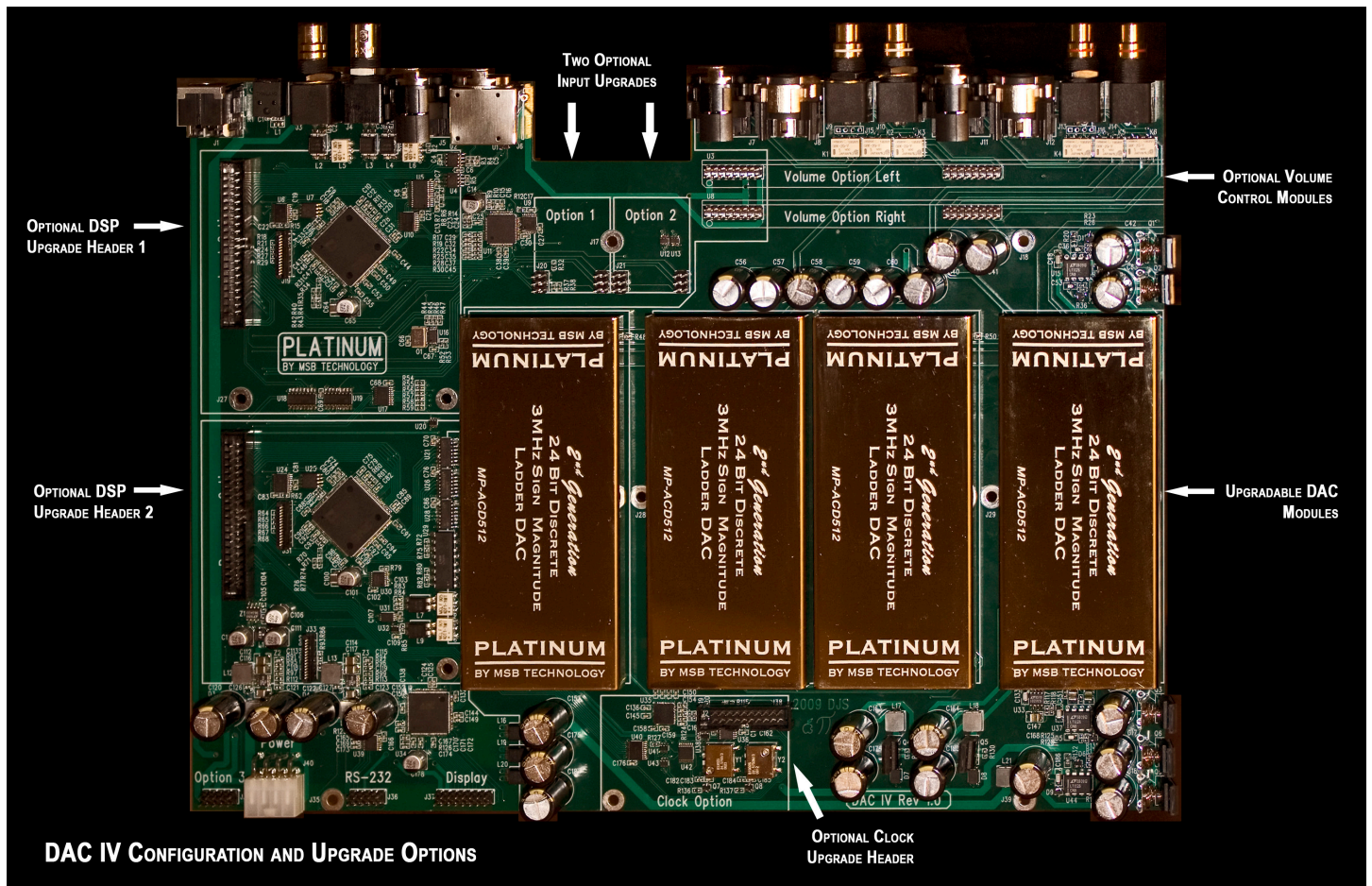

UPGRADES AND MODIFICATIONS

Removal of the cover - Unplug the AC power. Work on a clean surface. Start by removing the 14 screws of the cover. Carefully remove and set aside the cover.

Removal or Installation of the volume modules - The volume modules can be plugged in, or unplugged from the Platinum mother board. They are held in place with their two connectors. The boards are automatically detected, so when unplugged the DAC will output the same level signal as it would with them plugged in at 0 dB. The volume knob will now select the input and the remote volume buttons will have no effect.

Install the Signature DAC Upgrade - This upgrade provides hand matched DAC modules for superior sound quality. These DACs can run at twice the speed (384 kHz sampling rate) with 1/2 the settling time. The noise level is cut to 1/3 the normal value and the signal-to-noise ratio is up to 145 db. They are user installable and come as a matched set of four, replacing the existing DACs. Remove the clamp holding the DAC modules in. Pull each module straight out without tipping or twisting. Align the new module with the pins and push firmly back in. Take care that each connector is aligned. Do one DAC module at a time.

iLink II Upgrade - Remove the cover. Plug ribbon cable in "Aux 3". Install new cover.

Galaxy Femtosecond Clock Upgrade - Remove the cover. Plug the clock in the clock upgrade header. Install the clock mounting screw located in the cover of the clock box. Re-Install the cover.

Other Upgrades - Check the instructions supplied with the upgrade.

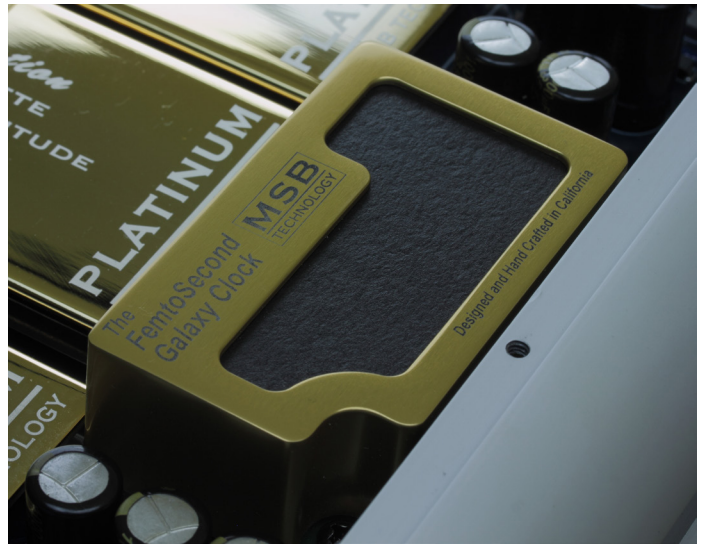

USB UPGRADES

The USB upgrades are common enough to include here rather than make a separate manual. For more detailed and up-to-date information check our web site. All three levels of USB input work basically the same, with the difference being the maximum sample rate they can receive.

Apple MAC OS

On the MAC the USB is plug and play. The MAC will recognize the USB DAC and its capabilities and will allow the output to be set to any sample rate desired. The bad news is, with certain programs such as iTunes, the output sample rate has to be set manually when the file sample rate changes. So if you set the output for 192 kHz, and played a 192 kHz file, it would play perfectly, but if you then played a 44.1 kHz CD, the MAC OS would upsample that file to 192 kHz. Computer upsampling is not too bad, but does not compare at all with the quality of the upsampling done by MSB. Better to change the output to 44.1 kHz and play the file bit-perfect. Fortunately there is an APP called BIT PERFECT. Download it and the MAC with the MSB USB 2 is perfection itself.

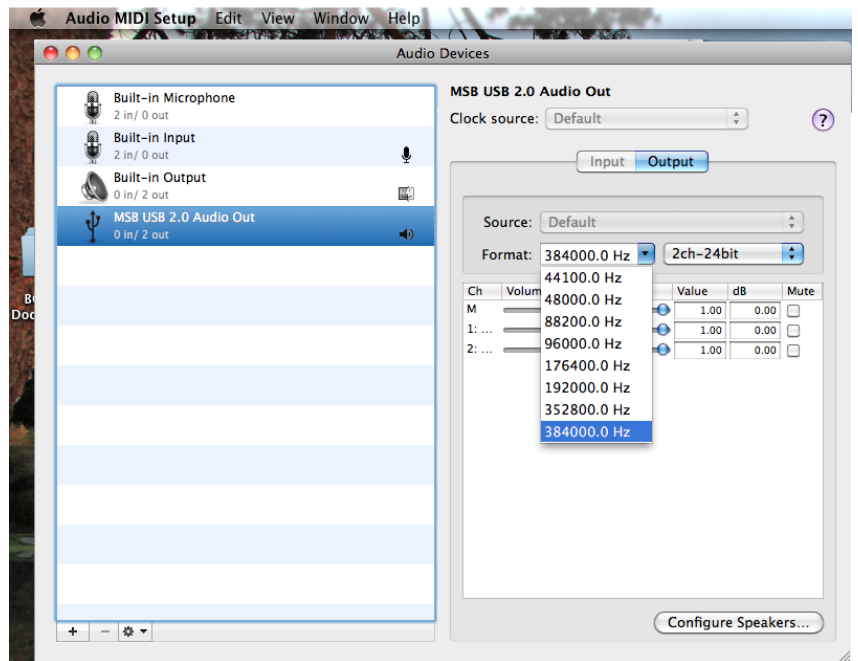

The Apple Audio MIDI Setup screen is shown above. Notice that the presence of the MSB USB Signature DAC has allowed 352.8 and 384 kHz sample rates to show up on the menu. Normally they are not present. iTunes will play at whatever sample rate you select in this setup.

Windows OS

The amazing thing about the MSB USB 2 input with Windows is that once you get it set up it works completely and absolutely perfectly, with every file playing bit-perfect at its native sample rate up to 384 kHz with no user intervention. Just pick the song and play. The rest is automatic and works perfectly. This is a first for any Windows machine I have seen and a dream come true. The bad is that MSB drivers will have to be installed, and your music must be played with a properly set up player program like Foobar. Its a small price to pay for perfection, and MSB will help walk you through the process.

First, install the supplied MSB drivers from the included USB 2 drivers CD or from our website (not necessary for USB 1 operation). So with a PC, there are two possible play modes. The “advanced speaker properties” window lets you set up Windows output sample rates up to 192 k as shown to the right. Any audio played by an audio program would be output at this sample rate. Specialty programs like Foobar can be modified with a plug-in, like ASIO (http://www.foobar2000.org/components/view/foo_out_asio) which allows Foobar to interact directly with the MSB DAC to play every music file at its native sample rate bit-perfect. Foobar over-rides all windows settings and is quite amazing.

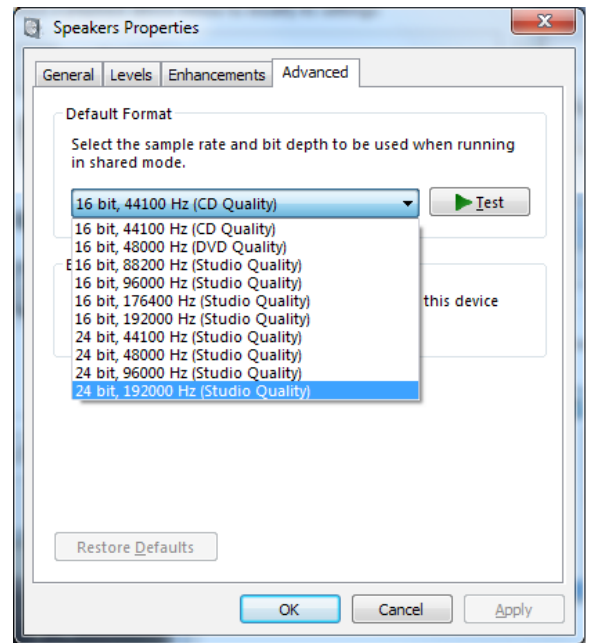

WORD SYNC UPGRADE

The DAC IV has a word sync option. First, a little bit about it. Word-sync is typically a master clock (in studios it’s known as the house clock) used in a system to keep everything synchronous. For playback systems, this isn’t all that important thus it’s very rare for someone to use in a home system. However it is important in studios as the output of the ADC convert needs to be synchronous to the digital inputs of the rest of the devices, such as computers. If it is not, they will have buffer overrun/underrun errors and data corruption.

When word-sync is used, they will run a standard digital signal (most common AES/EBU, but it could also be coaxial, etc...) along with a separate cable (typically BNC) that is the clock in word-sync format. Devices with a word-sync input look at both the data and the clock and run the entire device off the recovered word-sync clock. If a word-sync master clock is used, the entire system must run off of it. The word-sync clock is sample-rate dependent.

The DAC IV has the option of word-sync. We strongly recommend people not using it. Even if the word-sync clock source was perfect with 0 jitter, the act of converting it to the word-sync frequency, transmitting it, recovering it, and generating the correct frequency has 100 times the jitter of the standard clocks in our DAC. In order to use the word-sync option in our DAC, you must have the word-sync option that goes in the Aux 1 or Aux 2 slot.

One tricky thing we did is we tied the word-sync option to a specific input. In most cases when word sync is present, it will be there for one source to the DAC but the rest of the sources won’t be running off the house clock. In the menu, you will find the option “Word Sync.” When you enter this menu option, you will find a list of input names (coaxial, toslink, balanced, BNC). These are the inputs that can be used with the word sync source. Only one input can be used with the word-sync option.

For example, let’s say you have a transport with a word-sync input and you connect it to the DAC via the Balanced Digital input. You will need to connect both the transport and the DAC with the same word-sync signal (unless the transport is the word-sync source). Once this is done, you will go into the DAC menu and under word sync, select balanced. When the DAC switches to the balanced input, it will automatically enable the word-sync input. When you switch away from the balanced, it will turn the word-sync off. You can tell word-sync is working on the DAC as it will display “word sync” on the display when enabled.

Even though a server might have an excellent clock, it’s getting that clock from the server to the DAC without adding jitter that’s the problem. It would sound better to have the DAC do it’s relocking with the local clocks instead of running off a recovered word-sync clock from another box run over a cable.

PRO INPUT UPGRADE

This exciting upgrade adds one or two additional MSB inputs in the AUX IN positions of the DAC IV. It is a flexible board so please be careful to check the instructions carefully when installing. First of all, make sure your firmware has been upgraded to the latest level. Check the MSB web site for details. The upgrade offers two possible inputs:

Input #1 - Ground Isolated MSB Network

This is an improved version of the classic MSB Network. It will work with all existing MSB Network outputs on all current and older products. This input is designed specially as the best possible input for the MSB Universal Media Transport. It has the performance of the stock MSB Network without the coupling of ground noise. With this input both our transports can have optimal inputs. It will work with the following:

- Data CD IV
- Universal Media Transport
- All older MSB products



Input #2 - MSB PRO I2S

The MSB PRO I2S is new and will offer amazing performance on new transports as they are brought to market. (See the table) It is lower jitter and higher speed (ready for 768 kHz music) than the MSB Network. It contains 20 channels of audio of 768 kHz, 32 bit audio in the I2S format, as well as an outgoing clock and control data. These can be used to send multichannel data as would be required with digital crossovers, distribute independent super precision clocks and do auto setup of DAC parameters. Future upgrades and products will allow MSB products to take full advantage of these new capabilities. There is an PRO I2S output on our Studio 384 kHz, 32 bit ADC and this output will become the standard output on all new flagship MSB transports. So this input works with:

- MSB Pro Analog-to-digital Converter
- Signature Data CD
- Universal Media Transport PLUS and Signature Universal Media Transport, and all new products to come

The MSB PRO Input board upgrade not only gives you the improved MSB Network input you can use today, but also gives you a PRO I2S input that will be available for new MSB products in the future. The PRO upgrade can easily be configured for either type input.

Operation

These new inputs are added to the existing input LIST on the DAC and are selected just like the standard inputs. Please note that the MSB Network and the PRO I2S are independent. Network sources will only work with Network inputs, and PRO I2S sources will only work with PRO I2S inputs. So for today, the PRO board is configured for use with the MSB Network. As PRO I2S sources are developed by MSB, you will have an input to make use of them.

Installation

The Pro Input board plugs right in the input upgrade slot in the DAC IV. The Network connector installs in one of the AUX input holes. Unfortunately it is too big to fit in the older Diamond DAC IV without modifying the large heat sink. This job will need to be done by your dealer or by MSB.

QUALITY CHECK

Each Platinum is comprehensively tested and the actual outputs measured. Just a few comments on the example plot shown. The single spike is the test tone played at -60 db. A properly working DAC will produce a peak at -60. Most measurement systems cannot measure as low a level as -145 db. That is the noise floor of our production test system which means the Platinum may measure better, but we cannot see it. The rise at low frequencies is always present on our test setup and the right channel always shows a little more noise than the left (the right cable runs closer to the digital input cable).

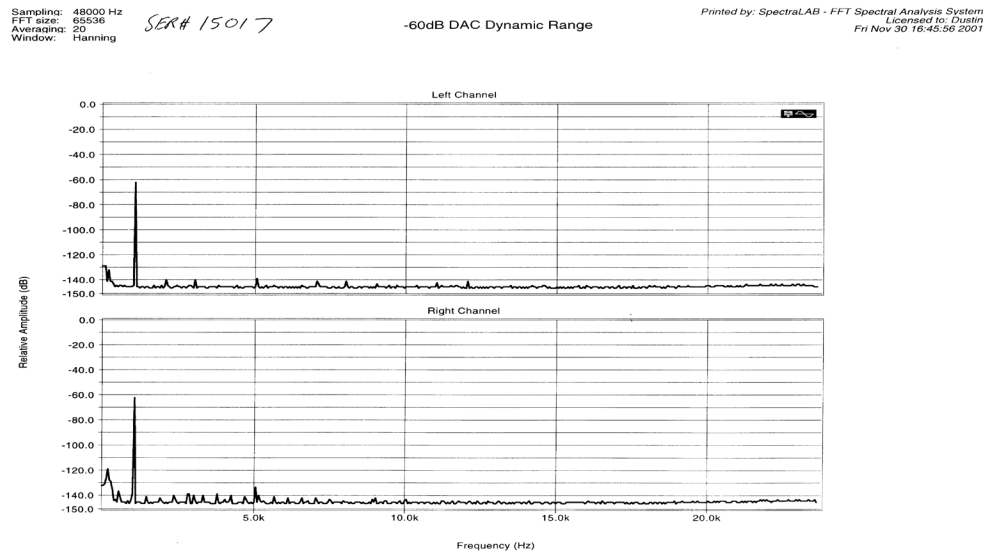

USING THE DAC IV TO TEST YOUR SOURCE

The DAC IV is unique in that gives you a precise read out of both the sample frequency and bit depth of the incoming signal as well as performing a test for bit perfect playback. If you are playing a CD, a copy of a CD or a ripped CD on your computer the display should read 44.1 kHz, 16 bit. Any other output means you are not reading the file bit-perfect and your sound quality will be compromised. This corruption could be accidental. You may have ripped a CD with a program that does a conversion. This is very bad and you should not do this. You may have an upsampling transport or have upsampled with software upsampling in your computer. This is also very bad. Nobody can do as well as we can if we are given the bit perfect original. Turn off the feature and give us the real thing. You will not be disappointed. For more detailed testing of your source, please refer to the BIT PERFECT SOURCE TESTING section of this manual. MSB provides test files that the DAC is programmed to recognize and check for bit perfect playback.

BIT-PERFECT SOURCE TESTING

Perhaps one of the most useful features of the software is the bit-perfect test. The following series of files can be downloaded from the MSB web site:

16 bit x 44.1 kHz sample rate file (CD standard).
16 bit x 48 kHz sample rate file.
16 bit x 88.2 kHz sample rate file.
16 bit x 96 kHz sample rate file.
16 bit x 176.4 kHz sample rate file.
16 bit x 192 kHz sample rate file.

24 bit x 44.1 kHz sample rate file.
24 bit x 48 kHz sample rate file.
24 bit x 88.2 kHz sample rate file.
24 bit x 96 kHz sample rate file.
24 bit x 176.4 kHz sample rate file.
24 bit x 192 kHz sample rate file.

They are .wav test files that when played, will be identified by the DAC IV and checked, and will be reported on the display if they are bit-perfect. If there is a problem with the test, it will play but the display will not indicate any change. Be sure upsampling is turned off in any transport as this prevents a file from remaining bit-perfect. This system will allow you to easily test your source, especially computer sources to see if all your settings are correct. There are files at all sample rates for both 16 bit and 24 bit operation. The 16 bit 44.1 test file can be burned to a CD to test transports.

TROUBLESHOOTING

No Input Frequency indicated on Display (reads “No Signal”) - This means no input is detected. Check input select. Change to auto mode to be sure. Check for bad cable, or cable plugged into the wrong output on the transport.

No Input Bit Depth indicated on Display (reads “0 bits”) - This means an input is detected but the music is not playing. Check the source to be sure it is playing.

No sound but Display indicates frequency and bit depth - Check that power cable is plugged in all the way. You may have digital power but no analog power. Check that source is valid audio source. Change to a standard CD just to be sure. Check that analog outputs are connected properly. Check that volume is turned up. If using Balanced output, check Single-End or Balanced menu setting. Balanced output will be silent if set to Single-Ended mode.

Still no sound - connect an analog output from the source directly to the preamp input. Verify that the rest of the system is working. Now move the same analog cable to the DAC and plug in the analog source to the analog inputs. Verify the DAC pass-through is working. Now plug in a digital source. You should hear a click and the front display should indicate frequency.

You hear audio clipping (with outboard preamp) - the output level may be too high for your preamp. Check the input specifications on your preamp. (See Platinum specs). If you do not have the volume option, go to the DAC LEVEL setup menu and reduce the DAC output to -9 dB. This reduced level should solve the problem.

Frequency readout is off - The Platinum shows the actual input frequency as well as the upsampled frequency. Check your source settings.

High sample rate source indicates 48 kHz on front panel - Check setup menu of source. Many products downmix to 48 k.

DVD-A source does not indicate 192 k - DVD-A players must be upgraded to provide a true 192K output. Production players downmix to 48K. Many DVD-A disks are produced in 44.1, 48 and 96 k as well.

DC on output when power is off - If the second Analog input option has been installed, the output is connected to the 2nd input when the power is turned off. Terminate the input when not used to avoid an open input to the AMP.

USB input not working right - Our USB1 input is limited to 48K 24 bit sources. Check your many computer settings. Our USB2 is limited to 192K and our USB2 Signature is limited to 384K. Check your computer settings. This is much harder than you would think. With many operating systems you may need to make small changes to the instructions. As ALWAYS with everything computer - Restart. Power off the computer and DAC and start over if anything is acting strange. Second thing is to change your USB cable. Audiophile USB cables rarely work at high sample rates. Try a cheap printer cable.

PRO Input is not working - Make sure you are not mixing a PRO I2S input and a MSB Network input. They are not compatible and will not work. Make sure you have the latest firmware.

Analog Input not selectable - This input defaults OFF. Go into the menus and turn on the Analog Input.

WARRANTY

All MSB products carry a one year warranty in the country of origin although extended warranties are offered in many countries. No returns accepted without an RMA. All units must be returned to the distributor in the country of origin. The DAC displays the distributor in the “about” tab of the menu. The power base has the distributor and country printed on the box. MSB will not make warranty repairs on grey market products. Be sure the product you purchased is authorized to be in your country. Upon receipt, MSB will repair or replace any defective product. All product shipped FOB Apts. Shipping and shipping damage is the responsibility of the consignee.